

9.0 AND 9.8 kW

mira

Advance
ATL THERMOSTATIC

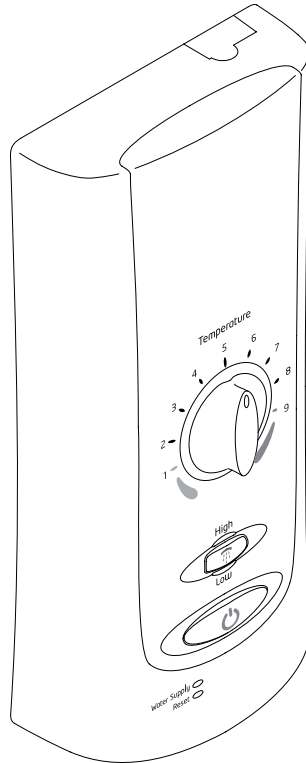

MIRA ADVANCE ATL
ADJUSTABLE TEMPERATURE LIMIT THERMOSTATIC

ELECTRIC SHOWER

Installation & User Guide

This product is suitable for mains fed cold water only.

These instructions are to be left with the user

CONTENTS

To The Customer	3
Important Safety Information	4
BEAB CARE Requirements	5
Pack Contents	6
Dimensions	7
Accessories	7
Specifications	8
1. Plumbing	8
2. Electrical.....	8
3. Standards and Approvals	8
4. Patents	8
Shower Performance	9
Installation Requirements	10
Installation	13
Priming the Unit.....	15
Commissioning	16
Adjustable Maximum Temperature Limit	16
BEAB Care Compliance	17
Operation	18
1. How your Shower Works.....	18
2. Using The Shower.....	19
3. Storing the Memory Presets (Memory Control Model only)	20
Automatic Shut Down.....	20
Fault Diagnosis	21
1. User Troubleshooting Guide.....	21
2. Installer Troubleshooting Guide.....	23
Maintenance	26
Wiring Diagram	27
Spare Parts	28
Notes	29
Customer Service	Back Page

TO THE CUSTOMER

Mira Advance ATL key features:

- Designed for safe and reliable control.
- Automatically adjusts to maintain constant temperature.
- Constantly monitors supply conditions.

Mira Advance ATL models covered by this guide

Product Variant	9.0	9.8	Adjustable Temperature Limit	Memory Push Button Feature	Extended Lever Control	Drain Pump Compatible
Standard	✓	✓	✓	✗	✗	✗
Memory	✓	✓	✓	✓	✗	✗
Flex	✓	✓	✓	✗	✓	✗
Standard Extra	✓	✗	✓	✗	✗	✓
Flex Extra	✓	✗	✓	✗	✓	✓

- The following separate drain kits are required for the "Extra" models:

SDP124T Mira Whale Tray Kit (complete with 50 mm gully)

SDP134T Mira Whale Wet Floor Kit (complete with wet gully for vinyl)

This product must only be used with a Whale Shower Drain Pump (included in the kits listed above).

Please pass on this guide in the event of change of ownership of the installation site.

If you experience any difficulty with the installation or operation of your new Electric Shower, then please refer to **"Fault Diagnosis"**, before contacting Kohler Mira Ltd. Our telephone and fax numbers can be found on the back cover of this guide.

IMPORTANT SAFETY INFORMATION

1. Warning!

- 1.1 Products manufactured by us are safe and without risk provided they are installed, used and maintained in good working order in accordance with our instructions and recommendations.
- 1.2 **THIS APPLIANCE MUST BE EARTHED.** Make sure any supplementary bonding complies with the "requirements for electrical installations" and is in accordance with **BS 7671**.
- 1.3 **DO NOT** twist the individual cable cores of the live and neutral conductors, as this will prevent them from entering the terminal block.
- 1.4 The shower unit must not be fitted where it may be exposed to freezing conditions. Make sure that any pipework that could become frozen is properly insulated. If the appliance appears to be frozen, allow to thaw and then contact your installer before using again.
DO NOT switch on the appliance if there is a possibility that the water in the heater is frozen.
- 1.5 **DO NOT** operate this appliance if water leaks from the Case. Maintenance may be required before the appliance can be safely used.
- 1.6 **DO NOT** fit any form of outlet flow control as the outlet acts as a vent for the tank body. Only Mira recommended outlet fittings should be used.
- 1.7 There are no user serviceable components beneath the cover of this appliance. Only a competent tradesperson should remove the cover and only genuine Mira replacement parts are to be used.
- 1.8 If any of the following conditions occur, isolate the electricity and water supplies. Contact your installer or refer to 'To contact us', on the back page of this guide:
 - 1.8.1 If the cover is not correctly fitted and water has entered the case.
 - 1.8.2 If the case is damaged.
 - 1.8.3 If the appliance begins to make an odd noise, smell or smoke.
 - 1.8.4 If the appliance shows signs of a distinct change in performance, indicating a need for maintenance.
- 1.9 Refer to the wiring diagram before checking any electrical connections.
- 1.10 Make sure all electrical connections are tight, to prevent arcing or overheating.

2. Caution!

- 2.1 Read all of these instructions and retain this guide for later use.
- 2.2 Follow all warnings, cautions and instructions contained in this guide, and on or inside the appliance.
- 2.3 The electrical installation must comply with the "Requirements for Electrical Installations" commonly referred to as the IEE Wiring Regulations, or any particular regulations and practices, specified by the local electricity supply company in force at the time of installation.

The installation should be carried out by an electrician or contractor who is registered, or is a member of, an association such as:

- Part P. (Building Regulations.)
- NICEIC approved domestic installer.
- The Electrical Contractors Association, England and Wales. (ECA.)
- The Electrical Contractors Association of Scotland. (SELECT.)

2.4 The plumbing installation must comply with the requirements of UK Water Regulations/Bye-laws (Scotland), Building Regulations or any particular regulations and practices, specified by the local water company or water undertakers. The installation should be carried out by a plumber or contractor who is registered, or is a member of, an association such as:

- Institute of Plumbing and Heating Engineering, throughout the UK. (IPHE.)
- Association of Plumbing and Heating Contractors, England and Wales. (APHC.)
- Scottish and Northern Ireland Plumbing Employers' Federation, Scotland and Northern Ireland. (SNIPEF.)

2.5 Anyone who may have difficulty understanding or operating the controls of any shower should be attended whilst showering. Particular consideration should be given to the young, the elderly, the infirm or anyone inexperienced in the correct operation of the controls. Children must be supervised to make sure that they do not play with the appliance.

2.6 When this appliance has reached the end of its serviceable life, it should be disposed of in a safe manner, in accordance with current local authority recycling, or waste disposal policy.

BEAB CARE Requirements:

Routine maintenance is required for all BEAB CARE installations. The Inlet Filter shall be cleaned or replaced after the first 6 months of use. This shall then be repeated every 12 months. Refer to section: "**Maintenance**", on how to safely remove the Filter.

Year	6 Monthly	Signature	12 Monthly	Signature
1				
2				
3				
4				
5				
6				
7				
8				
9				
10				

PACK CONTENTS



Tick the appropriate boxes to familiarize yourself with the part names and to confirm that the parts are included.

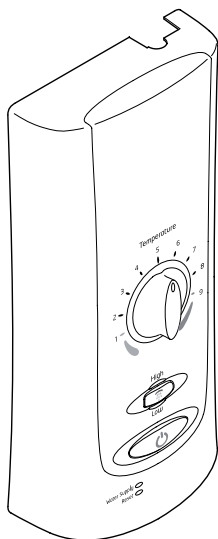

Or

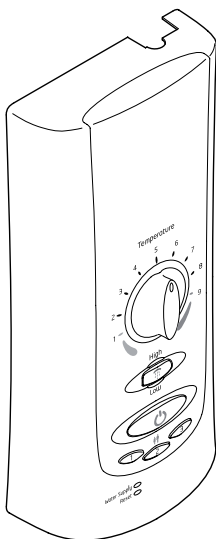

Or

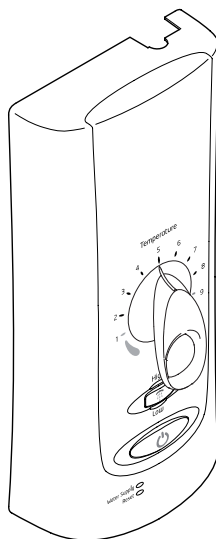

1 x Mira Advance ATL Standard or Standard Extra (Whale Shower Drain Pump supplied separately)

1 x Mira Advance ATL Memory

1 x Mira Advance ATL Flex or Flex Extra (Whale Shower Drain Pump supplied separately)



1 x Compression Nut



1 x Olive



1 x Tap Connector Adaptor (for fitting to existing tap connector)

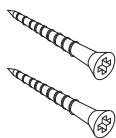

2 x Wall Screws

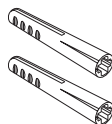

2 x Wall Plugs

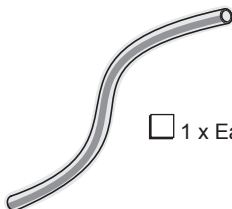

1 x Earth Sleeve

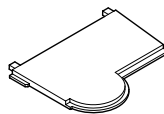

1 x Case Insert Top

- 1 x Installation and User Guide
- 1 x Installer Checklist
- 1 x Installation Template
- 1 x Guarantee Card

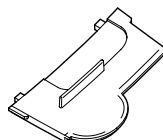

1 x Case Insert Bottom

DIMENSIONS

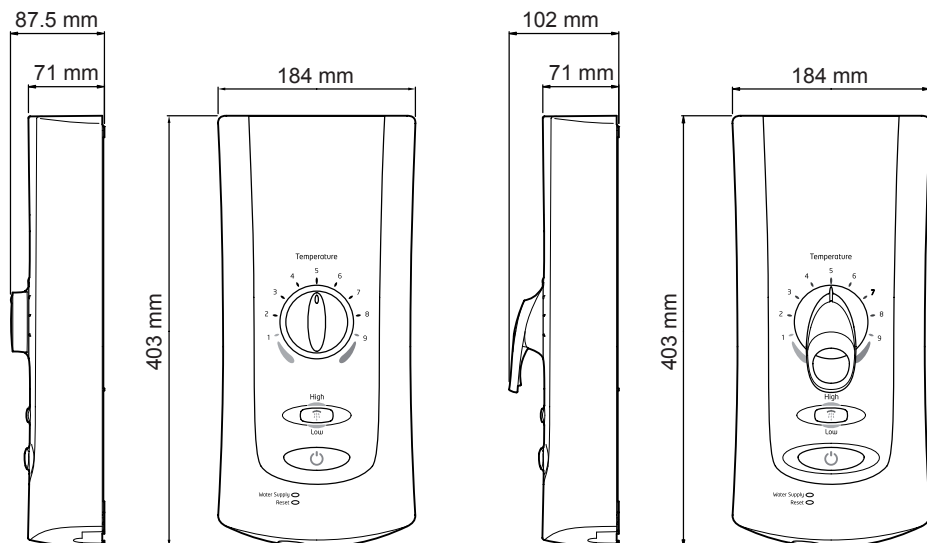

Advance ATL
Standard/Memory

Advance ATL Flex

All dimensions are nominal

ACCESSORIES

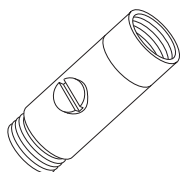

MIRA DCV-H OUTLET DOUBLE CHECKVALVE.

Designed to prevent the backflow or backsiphonage of potentially contaminated water, through shower controls which are fitted with a flexible hose as part of the outlet shower fitting. Available as an optional accessory from all Mira Showers stockists.

SPECIFICATIONS

Plumbing Supply	Supply Source	Mains pressure cold water only	
	Minimum Dynamic Pressure*	50 kPa (0.5 bar)	
	Maximum Static Pressure	1000 kPa (10 bar)	
	Minimum Static Pressure**	20 kPa (0.2 bar)	
	Maximum Inlet Temperature	28°C	
	Minimum Inlet Temperature	2°C	
	Inlet Connection	½" BSP male & 15 mm compression fitting.	
	Outlet Connection	½" BSP male fitting	
Electrical Supply	Nominal Rating at 230 V	8.2 kW	9.0 kW
	Nominal Rating at 240 V	9.0 kW	9.8 kW
	Supply Fuse/Circuit Breaker	9.0 kW	40 Amps
		9.8 kW	45 Amps
	Residual Current Device RCD (Strongly Recommended)	30 mA	
	Supply Cable	No larger than 16 mm ² Note: Refer to current IEE regulations and BS 7671 to determine minimum cable size.	
	Isolation Switch	45 Amp Double pole, with 3 mm contact separation.	
Maximum Ambient Temperature	30°C		
Minimum Ambient Temperature	2°C		

* Recommended dynamic pressure of 100 kPa (1.0 bar) for full flow performance.

** Static pressure must never fall below 20 kPa (0.2 bar) when other draw offs are in use, e.g. flushing toilet. This is the minimum pressure required to keep the flow valve closed.

Standards and Approvals

The Mira Advance ATL complies with the requirements of the BEAB Care Mark Standard and the relevant directives for CE marking.

Patents and Design Registration

Design Registration:	000738141: 0003, 0006, 0007, 0009
Patents:	GB: 2269466, 2270370, 2298478, 2298479, 2298481

SHOWER PERFORMANCE

What affects shower performance?

The shower unit's top priority is to keep the desired water temperature constant. To maintain this temperature, the shower may have to automatically change the rate of water flowing through the unit. Any of the following conditions can cause the shower to change the flow rate (force of the shower) in order to keep the temperature constant. Most changes are minor and will go unnoticed.



Seasonal changes affecting water supply temperature.

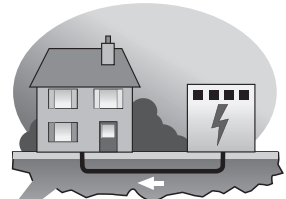

Changes of incoming supply voltage.



Changes in Flow Rate (force of shower).
Temperature remains constant.

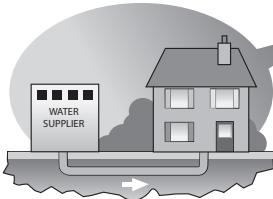

Changes of incoming supply pressure.

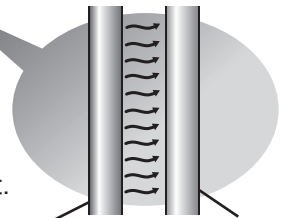

hot pipe
mains cold pipe

Heat transfer due to position of mains cold water pipe.

- E.g.
- Positioned next to hot water pipe.
 - Routed through heated area such as loft or airing cupboard.



Mains cold water draw off, e.g. toilet, wash basin etc.

INSTALLATION REQUIREMENTS

General Notes

This product works best when supply temperatures and pressures remain stable and within the product specifications, refer to section "**Specifications**". If the supply conditions fall outside the specifications, the shower may go into a safe shut down condition.

1. Plumbing Do's & Don'ts

Refer to section: "**Important Safety Information**" first.

- 1.1 Do not use sealing compounds on any pipe fittings or joints.
- 1.2 Never fit the unit to hot water supplies or to gravity systems of any description. Only fit the product to a mains cold water pipe.
- 1.3 Avoid layouts where the shower hose will be sharply kinked. This may reduce the life of the hose.
- 1.4 Supply pipework **MUST** be flushed to clear debris before connecting the appliance. Debris will reduce the performance of the unit.
Avoid running the pipework through excessively hot or cold areas such as hot loft spaces, airing cupboards, or in close proximity to hot water pipes. If this cannot be avoided, we would recommend insulating the pipes.
- 1.5 The appliance must be fitted onto the finished wall surface i.e. on top of the tiles. **DO NOT** tile up to the sides of the unit or use a sealant around the case. Failure to do this may cause product failure.
- 1.6 We recommend that a non-restrictive (free flowing) isolating valve is fitted in the cold water supply pipe to allow maintenance of the appliance.
- 1.7 When installed in very hard water areas (above 200 ppm temporary hardness) your installer may advise the installation of a water treatment device, to reduce the effects of limescale formation. Any malfunction due to limescale is not covered by the manufacturer's guarantee. Your local water company will be able to advise the hardness of water in your area.
- 1.8 **Caution!** Double checkvalves, fitted in the inlet supply to the appliance, cause a pressure buildup, which could exceed the maximum static inlet pressure for the appliance.

2. Electrical

Refer to section: "**Important Safety Information**" first.

- 2.1 In a domestic installation, the rating of the electricity supplier's fuse and the consumer unit must be adequate for the additional demand. All Mira Advance ATL electric showers are high power units. Voltage drop due to local heavy demand will reduce the shower's performance.

- 2.2 The appliance must be earthed by connecting the supply-cable earth conductor to the earth terminal.
Any supplementary bonding and supply cable size must conform to **BS 7671**.
 - 2.3 As a guide only, and in accordance with **BS 7671** we recommend close circuit protection:
I.e. **9.0 kW = 40 Amp**
9.8 kW = 45 Amp
- A separate, permanently connected supply is taken from the consumer unit to the appliance through a double-pole switch. The switch can be a ceiling mounted pullcord type or a wall mounted switch in an adjacent room.
- 2.4 **DO NOT** exert strain on the terminal block, however make sure that the electrical connections are tightly screwed down.
 - 2.5 **DO NOT** turn on the electrical supply until the plumbing has been completed.

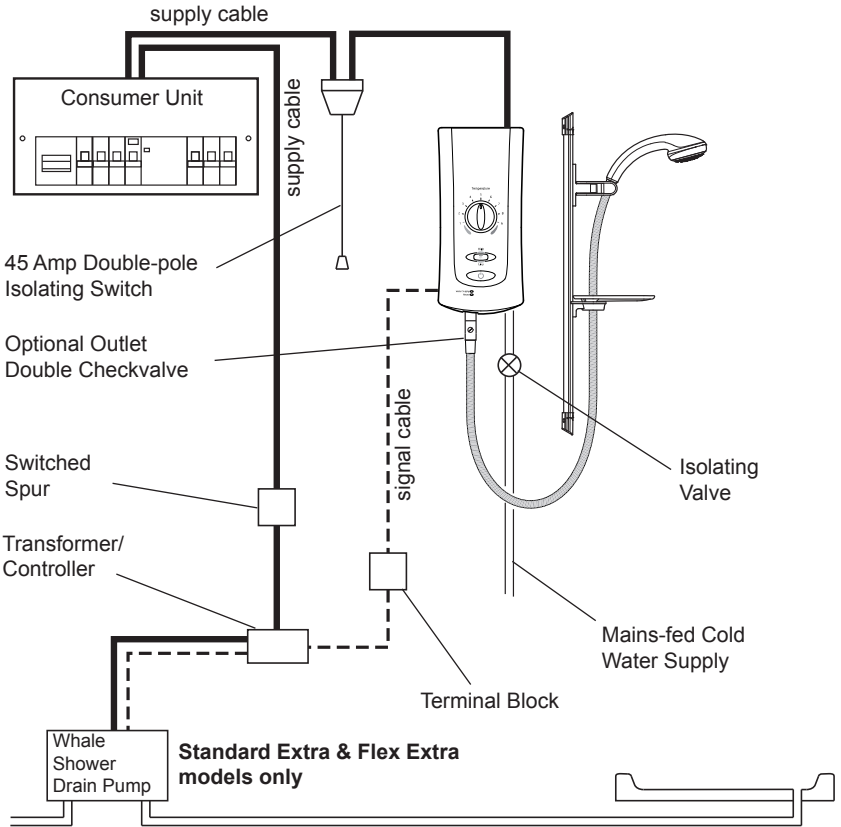

Plumbing and Electrical Schematic Diagram

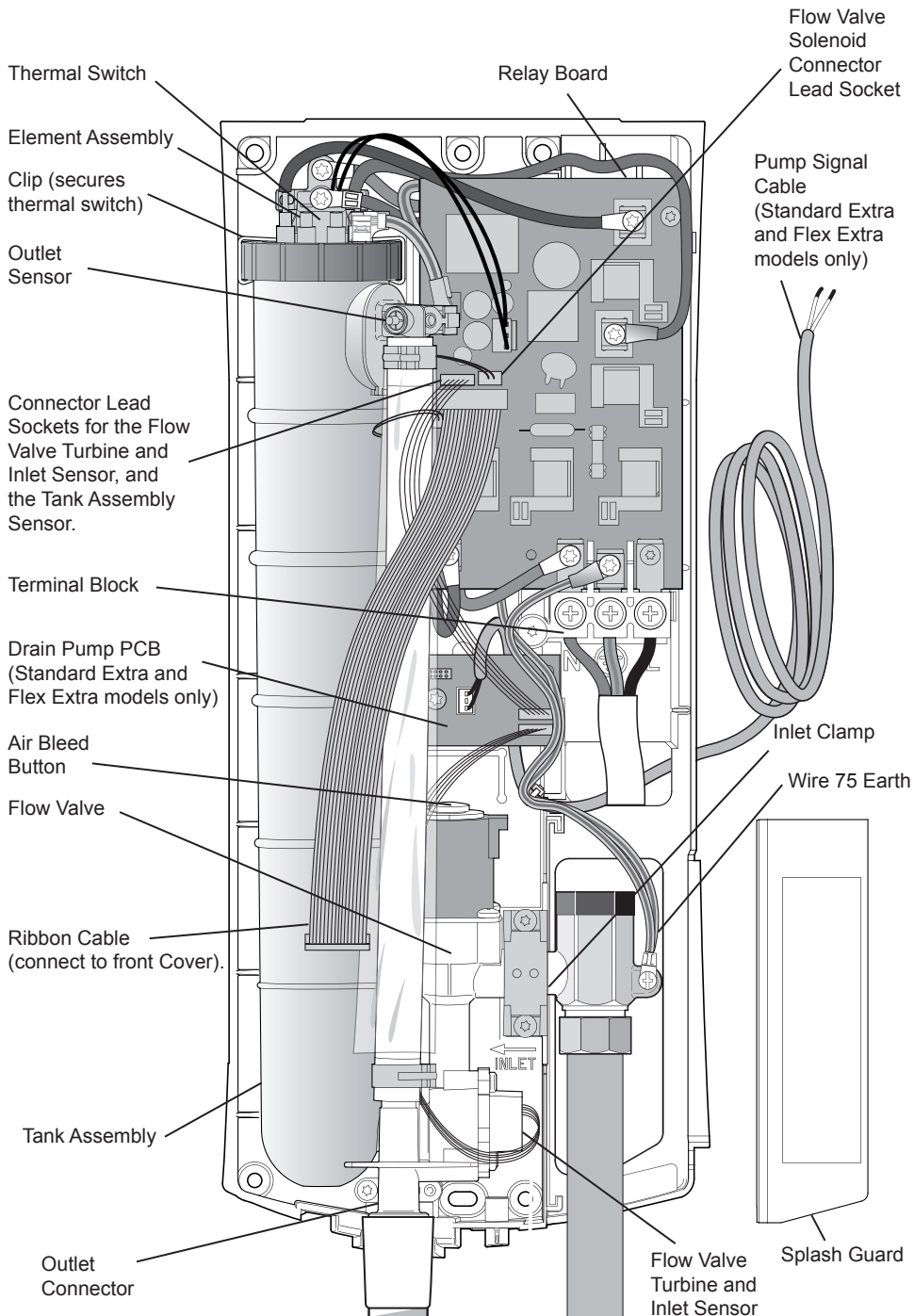

Mira Advance ATL

(Standard Extra and Flex Extra models shown)

INSTALLATION

Refer to section: "Important Safety Information" first.

This installation covers all models of the Mira Advance ATL Thermostatic shower.

1.



Electrical supply is turned off at the mains.

2.

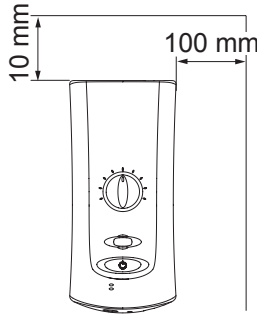

Determine unit position. Leave appropriate spaces for maintenance.

3.

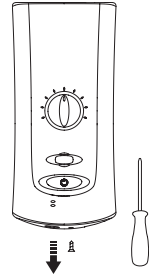

Remove Cover Screw.

4.

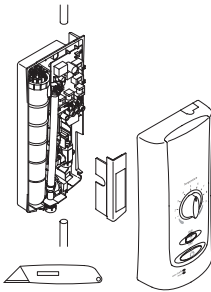

Remove Cover and Splash Guard. Determine supply pipe position and if required cut a slot in the Case for the rising supply.

5.

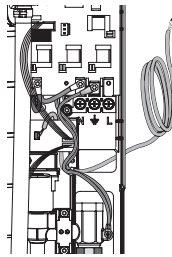

Make provision for Signal Cable to connect to Shower Drain Pump (if applicable). Also refer to Whale Drain Pump instructions.

6.

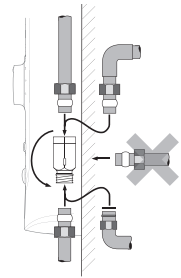

Turn Inlet Connector to suit supply pipe. **Do not** trap green wire.

7.

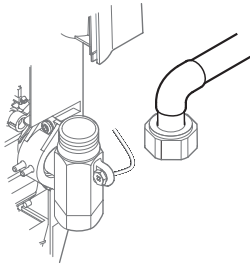

Complete any soldering required away from appliance.

8.

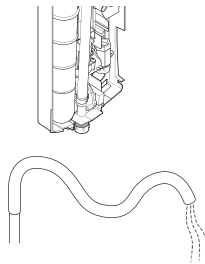

Flush a minimum of 10 litres (2 gallons) through pipework prior to connection.

9.

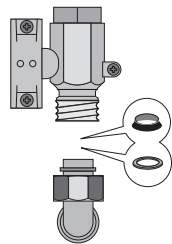

When fitting to a tap connection, use adaptor (supplied). **Do not** fit fibre washer.

10.

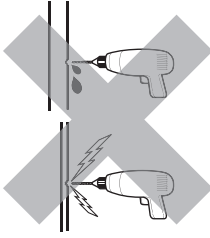

CAUTION! Do not drill into buried cables or pipes.

11.

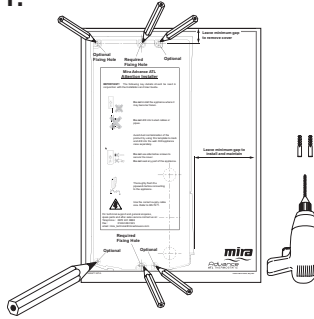

Use Template provided to mark and drill required fixing holes. Screws and Plugs are supplied for two required holes only.

12.

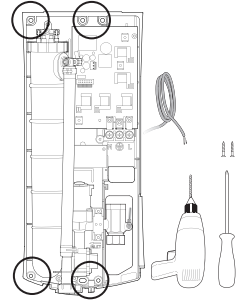

Drill holes through plastic case as required. Route signal cable to Shower Drain Pump (if applicable). Fix appliance to wall.

13.

Mira Advance ATL Standard Extra & Flex Extra variants only!

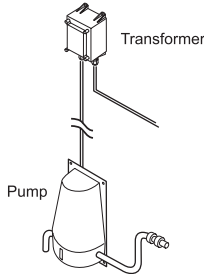

Find the Whale Shower Drain Pump Transformer and identify its type number.

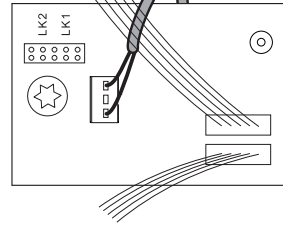

Jumper position for Mira Advance ATL Drain Pump PCB.

Type: 755.171 = LK1

Type: 755.299 = LK2

14.

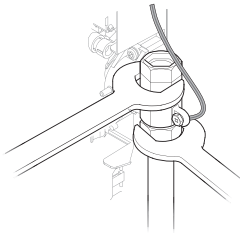

Connect supply pipe. Do not overtighten.

15.

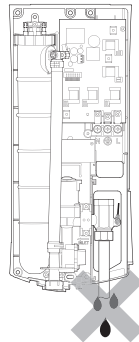

Turn on water supply and check for leaks.

16.

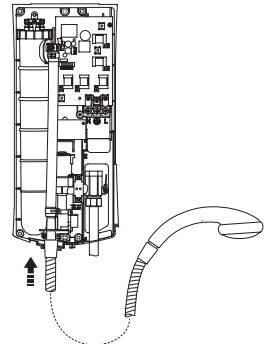

Connect hose and handset, pointing into bath or tray.

17.

IMPORTANT!
Priming the unit

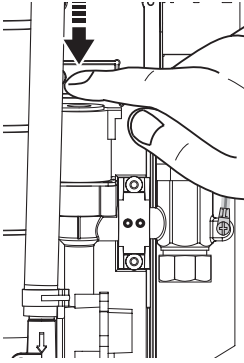

Make sure electricity is isolated! Push down and hold air bleed button to prime appliance until water appears from shower head. **Failure to prime will seriously affect shower performance!** Dry off water before connecting/reinstating electricity.

18.

L = BROWN

E = GREEN

N = BLUE

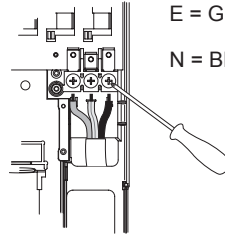

Feed cable into case. Fit earth sleeve and strip insulation. Firmly connect the conductors. Do not exert strain on terminal block.

19.

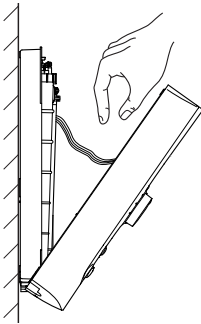

Refit Splash Guard and connect ribbon cable to the inside of the Cover.

20.

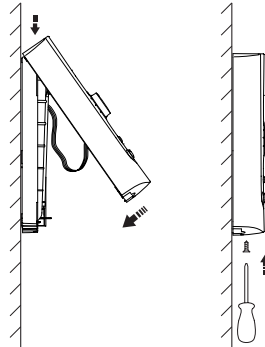

Refit Cover. Inserts are provided to finish the top and bottom as required.

21.

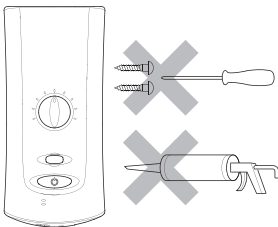

Do not use alternative screws to secure Cover. This can cause internal damage to the appliance. Do not seal around any part of the appliance.

22.

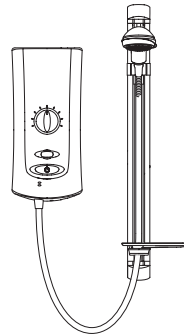

Install shower fittings. Refer to separate Installation and User Guide.

COMMISSIONING

Important! The Mira Advance ATL will adapt it's settings for the individual supply conditions and store this information in it's main memory (during manufacture, this information is factory set using ideal conditions). On initial installation, the unit needs to "learn" about the site conditions and does so during the commissioning cycle. It is important that the unit is commissioned correctly otherwise an error condition may occur. Once set, the unit constantly updates it's memory with information about the site conditions to optimize the shower's performance. This is stored once the **Start/Stop** button is pressed whilst the shower is running.

Basic Operation Checks

1. Switch on the electrical supply at the mains and test the Shower Drain Pump (if applicable, see separate Shower Drain Pump instructions) **before** turning the shower on. Switch on the electrical supply at the double-pole switch. The **Start/Stop** button will illuminate to indicate that the electrical supply is connected to the shower.
2. Turn the **Temperature control dial** to **full cold**, the dial operates anticlockwise from hot to cold.
3. Push the **Flow** or **Start/Stop** button and observe the blue flow indicator with audible beep. Check that cold water flows freely from the shower within a few seconds. If a delay of more than 5 seconds is encountered, then it is likely that the unit has not been primed.

Refer to section "**Installation**" for priming the unit using the air bleed button. Should the unit still not function then refer to the section "**Fault Diagnosis**".

After a short delay, the Shower Drain Pump (if applicable) should operate and drain the waste water, after the shower is turned on.

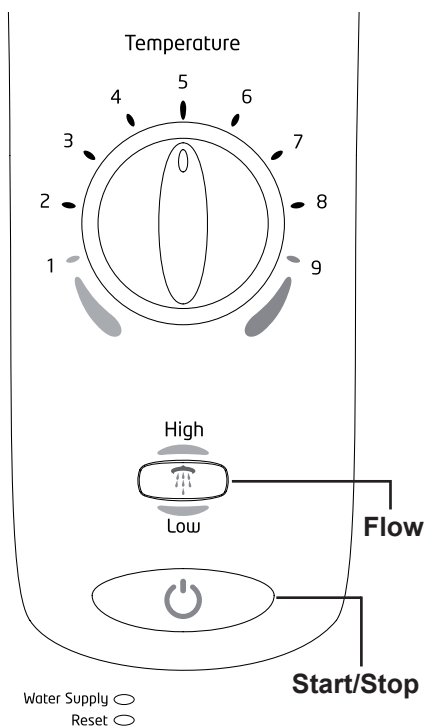

Adjusting Maximum Temperature Limit and Commissioning Cycle

4. Make sure the double pole switch is off.
5. Set the **Temperature control dial** to the position required for the correct temperature as shown in the following table.
6. Switch on the double pole switch and check the blue **Start/Stop** button is lit.

7. **Within 30 seconds**, push and hold down the **Flow** and **Start/Stop** buttons at the same time.
8. On the long beep, release the **Start/Stop** button. On the short beep, release the **Flow** button.

Following the **Maximum Temperature Setting** procedure, the appliance automatically starts a **Commissioning** process to check and adjust to the site conditions. The **High Flow** light flashes for approximately 2 minutes. **Caution! During this cycle the water temperature will reach a maximum of 44 °C.** At the end the **Flow** light goes off, the shower stops and goes to the normal standby mode. The maximum temperature limit can be further reset to any temperature within the table by repeating this process. The shower is now ready for use.

Dial Position	Max. Temp °C
1	37
2	38
3	39
4	40
5	41
6	42
7	45
8	48



**BEAB Care
Temperature
Range**

If the unit's maximum temperature is set to 41 °C or cooler, there is a clear triple beep tone and single flash of the **Start/Stop** light when double pole switch is turned back on. This is to show that the unit is in a "**BEAB Care**" compliant mode. If recommissioning is required whilst in this mode, wait until beeps have passed before starting the commissioning cycle.

Memory model: if the maximum temperature is adjusted **after** having been stored in one or more of the memory buttons, then the showering temperature cannot exceed the **new maximum setting**.

E.g.

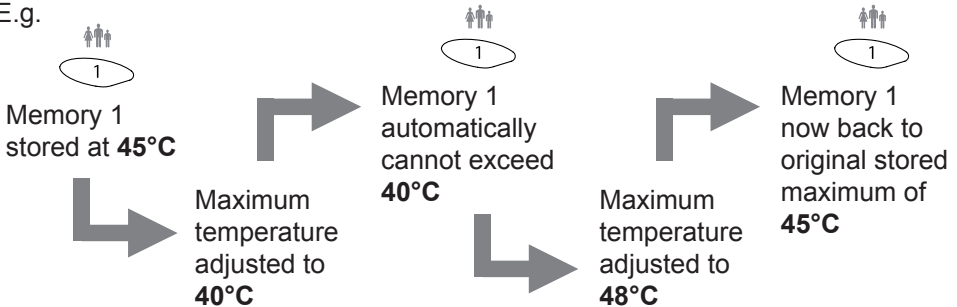

Note! High cold water mains supply pressures and high shower temperatures will cause a slight audible hissing sound to be heard from the unit whilst it is operating. This is quite normal and does not indicate that there is a fault with the unit.

OPERATION

1. How your Shower Works

1.1 Hot water is produced by passing cold water through a heating tank.

The unit constantly monitors the following conditions:

- The incoming cold water temperature.
- The outgoing shower temperature.
- The flow rate of water.
- The current user settings.

The flow rate may automatically adjust to maintain the current temperature setting. As part of this process, a series of "clicks" may be heard, this is a normal part of the operation when the shower is in use.

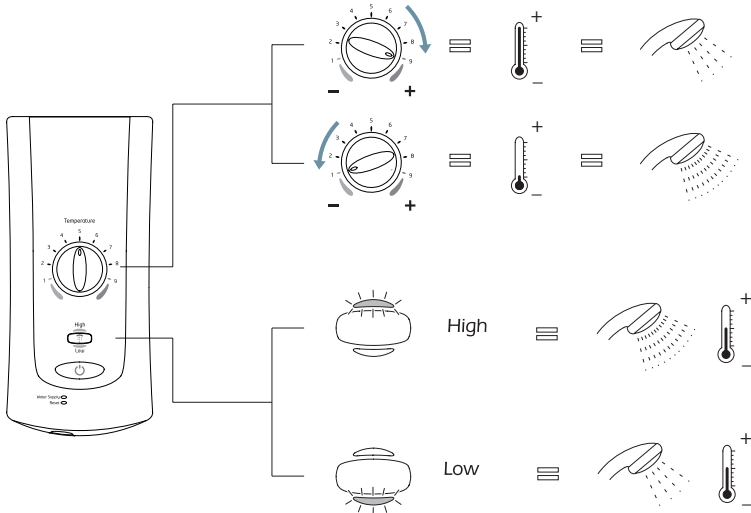
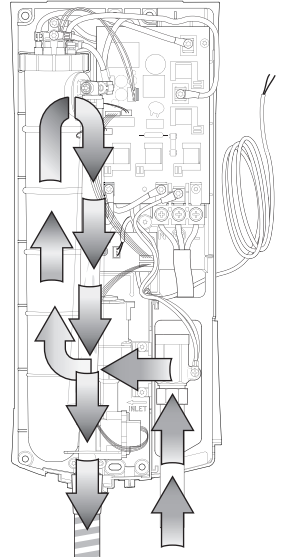

The showering temperature is adjusted by turning the **Temperature Control Dial**, which varies the flow of cold water passing over the elements. The slower the rate of flow, the warmer the shower and vice versa.

As outlined in section **"Shower Performance"**, certain conditions can cause the shower's performance to vary. The most common of these conditions is detailed below:

1.2 The Effect of Other Water Devices

Temporary changes in supply conditions can cause reduced flow performance. The selected flow setting may not be available until supply returns to normal.

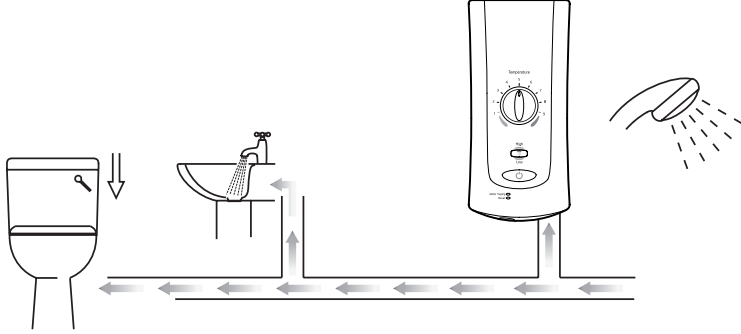

Thermostatic Performance

To maintain thermostatic performance, the unit may override the selected flow condition. The selected flow indicated does NOT change.

2. Using the Shower

Refer to section: **"Important Safety Information"** first.

1.

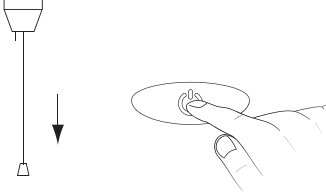

Turn on electrical supply and push **Start/Stop**.

2.

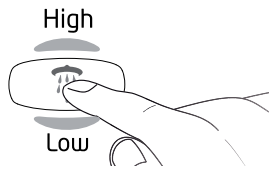

Select the desired flow by pushing either once or twice.

3.



Check water temperature before entering shower.

4.

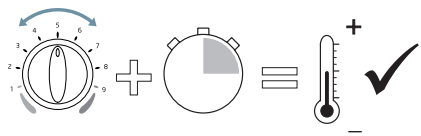

Allow 10-15 seconds for any temperature adjustments to reach the handset.

5.



Push **Start/Stop BEFORE** isolating the electricity. The flashing light indicates the shower is shutting down.

6.

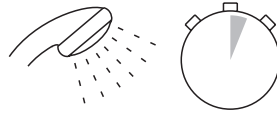

The shower will purge water from its tank for a few seconds.

7.



Residual water may drain over a few minutes

3. Storing the Memory Presets (Memory Control Model only)

1.

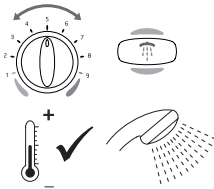

Set the shower to the desired temperature and flow.

2.

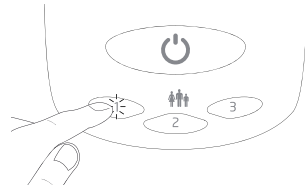

Push and hold down the desired memory button. A "beep" and flashing light will indicate the setting has been stored successfully.

3.

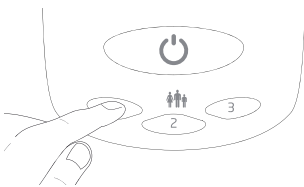

To retrieve a stored setting, push the desired memory button when the shower is either on or off.

Note! The unit has a built in "Shower Stop" timer function to protect from accidental unattended operation. This feature automatically switches the unit **off** after **40 minutes** of continuous use. Normal operation is restored by re-selecting the **Start/Stop** button.

Any light flashing rapidly will indicate the button pushed is stuck.

FAULT DIAGNOSIS

1. User Troubleshooting Guide

The Mira Advance ATL electric shower is fully performance tested after assembly. In the unlikely event that you experience problems with the appliance, then the following procedures will enable you to undertake basic troubleshooting before contacting the competent tradesperson responsible for installing your shower.

Warning! There are no **user** serviceable components beneath the cover of the appliance.

Only a competent tradesperson should remove the cover whilst observing the warnings given in section "**2. Installer Troubleshooting Guide**" prior to performing any maintenance.

Water Supply Light

The **Water Supply** is a warning light that will flash or be lit solid together with a beeping tone in the event of:

- Incoming water temperature is too high.
- Incoming water pressure is too low.

Showering performance will be reduced until the supply is restored to the required conditions. Refer to "**Specifications**". Once the supply is restored, the **Water Supply** light will go out. For the most likely causes of reduced shower performance, refer to "**Shower Performance**" and "**Operation**".

If the warning continues, contact a competent tradesperson who can further investigate the cause.

Reset Light

The shower automatically stops and the **Reset** light will flash or be lit solid together with a beeping tone in the event of:

- Appliance failure
- Supply conditions that may cause unsafe showering.

Other indicator lights will vary depending upon the fault. If any other fault condition occurs that is not listed in this guide, contact the installer or Mira Customer Service Dept.

User Troubleshooting Guide (continued)

Resetting the Unit

This is the first solution to the shower not operating.

Reset the unit by turning the electricity off and on again at the isolating switch. After turning the electricity back on, the **Start/Stop** button will bleep once and flash for approximately 15 seconds before the appliance is ready for use. If the failure continues after resetting, there are a few basic supply checks that can be performed:

- Check there is electricity supplied to the unit. (Lights and/or beeps will confirm this.) If in any doubt, contact a qualified electrician.
- Check all plumbing isolator valves to the shower are turned on full.
- A section of supply pipe may be preheating the cold water supply to the shower. E.g. cold water supply pipe is running through a loft or is adjacent to hot water pipes.
- A section of supply pipe is frozen. Allow to thaw and insulate the pipe.
- **In rare cases**, hot water may be retained within the unit causing a failure to continue even though the underlying cause may have been corrected. Allowing the water to cool for approximately 20 minutes before use should clear this error.

If a failure still continues after all of these checks are complete and the unit has once again been reset, then contact a competent tradesperson who can further diagnose the fault.

2. Installer Troubleshooting Guide

Refer to section: 'Important Safety Information' first.

The following tables are for a competent tradesperson to check against only.

Warning! Isolate the electrical and water supply before removing the cover.

Warning! Mains connections are exposed when the cover is removed.

Warning! Refer to wiring diagram before making any electrical connections.

Warning! Make sure all electrical connections are tight to prevent arcing/overheating.

Warning! Make sure all plumbing connections are watertight.

Warning! Make sure Ribbon Cable is disconnected when removing the front cover and reconnect when maintenance is complete.

Providing the appliance has been correctly installed and is operated in accordance with the instructions contained in this guide, difficulties should not arise. If any maintenance is required then it must be carried out by a competent tradesperson for whom the fault diagnosis chart and wiring diagram are provided. Before replacing any parts make sure that the underlying cause of the malfunction has been resolved.

When following these instructions, it is sometimes necessary to examine the appliance with the electrical and water supplies turned **on**. It is therefore essential that the appropriate safe working practices are followed in accordance with the current Health and Safety Legislation.





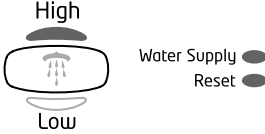

When the mains supply is **ISOLATED** a multimeter can be used to carry out a continuity check on certain components (e.g. supply fuse, heating elements, thermal switch, etc.).

No light ○ Flashing light ⚡ Solid light ●

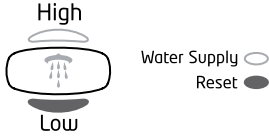
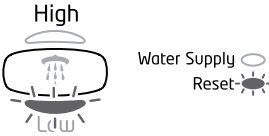
Indicator Display	Cause/Rectification
	<p>Incoming water flow too low for appliance to operate safely, faulty Thermal Trip or faulty Heater Tank.</p> <ol style="list-style-type: none"> 1. Reset the unit. 2. Check all plumbing isolator valves to the shower are turned fully on. 3. A section of the supply pipe is frozen, allow to thaw and insulate the pipe. 4. Replace Thermal Trip. 5. Replace Heater Tank.

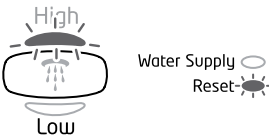
cont...

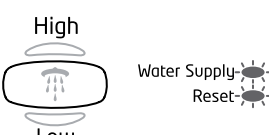
No light ○ Flashing light  Solid light ●

Indicator Display	Cause/Rectification
 <p>High Low</p> <p>Water Supply ○ Reset ●</p>	<p>Problem with electrical supply, faulty Control PCB or faulty Relay Board.</p> <ol style="list-style-type: none"> 1. Reset the unit. 2. Replace Control PCB 3. Replace Relay Board.
 <p>High Low</p> <p>Water Supply ○ Reset </p>	<p>Control PCB failure.</p> <ol style="list-style-type: none"> 1. Reset the unit. 2. Replace Control PCB. <p>Incoming water temperature too high, faulty Control PCB or faulty Flow Valve Assembly.</p> <ol style="list-style-type: none"> 1. Reset the unit. 2. Check mains water temperature. 3. Replace Control PCB. 4. Replace Flow Valve Assembly.
 <p>High Low</p> <p>Water Supply  Reset </p>	<p>Safety relay failure, faulty Control PCB or faulty Relay Board.</p> <ol style="list-style-type: none"> 1. Reset the unit. 2. Check relay contacts. 3. Replace Control PCB. 4. Replace Relay Board.
 <p>High Low</p> <p>Water Supply  Reset </p>	<p>Unit is frozen, Flow Valve Assembly is disconnected or faulty.</p> <ol style="list-style-type: none"> 1. Reset the unit. 2. Check Flow Valve connection. 3. Check unit is not frozen. 4. Replace Control PCB. 5. Replace Flow Valve Assembly.

No light ○ Flashing light ⚡ Solid light ●

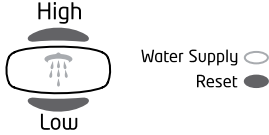
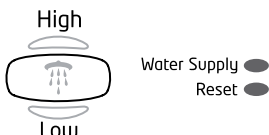
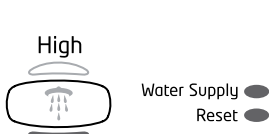
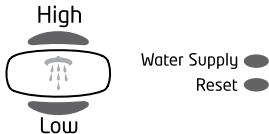
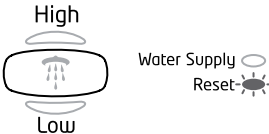
Indicator Display	Cause/Rectification
 <p>High</p> <p>Water Supply ○ Reset ●</p> <p>Low</p>	<p>Problem with electrical supply, faulty Control PCB or faulty Relay Board.</p> <ol style="list-style-type: none"> 1. Reset the unit. 2. Replace Control PCB. 3. Replace Relay Board.
 <p>High</p> <p>Water Supply ● Reset ●</p> <p>Low</p>	<p>Unit is frozen, Outlet Sensor disconnected from Relay Board or faulty Control PCB.</p> <ol style="list-style-type: none"> 1. Reset the unit. 2. Check unit is not frozen. 3. Check Outlet Sensor connection to Relay Board. 4. Replace Control PCB.
 <p>High</p> <p>Water Supply ● Reset ●</p> <p>Low</p>	<p>Unsafe hot water detected, faulty Control PCB, faulty Relay Board or faulty Outlet Sensor.</p> <ol style="list-style-type: none"> 1. Wait 15 minutes for water to cool. Reset the unit. 2. Check Outlet Sensor connection to Relay Board. 3. Replace Control PCB. 4. Replace Relay Board. 5. Replace Heater Tank Assembly.
 <p>High</p> <p>Water Supply ● Reset ●</p> <p>Low</p>	<p>False flow reading.</p> <ol style="list-style-type: none"> 1. Reset the unit. 2. Re-prime the unit, see section "Installation". 3. Replace Flow Valve Assembly.
 <p>High</p> <p>Water Supply ○ Reset ⚡</p> <p>Low</p>	<p>Possible Heater Failure.</p> <ol style="list-style-type: none"> 1. Reset the unit. 2. Check resistance of Heater Tank elements. 3. Replace Heater Tank Assembly with an appropriately rated spare.

MAINTENANCE

User Maintenance - Handset Cleaning

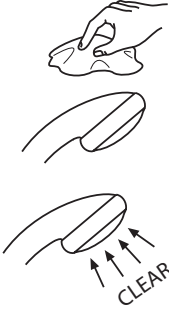

Clean with mild washing up detergent or soap solution. Wipe dry with soft cloth.

Poor shower performance can be avoided by cleaning the spray plate. Use thumb or soft cloth to wipe rubber nozzles. The handset shall be descaled regularly to stop the handset getting blocked.

Tradesperson Maintenance - Inlet Filter Cleaning/Replacing

Read the section "**Important Safety Information**" first.

1.

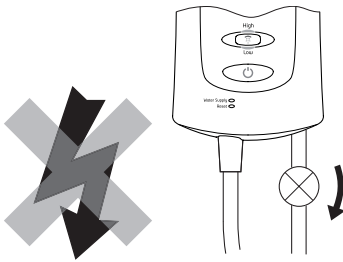

Electrical and water supplies to the appliance are turned off.

2.

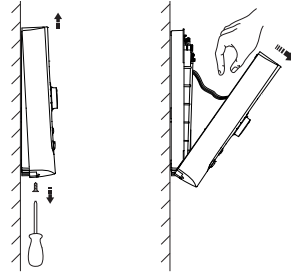

Remove the Cover screw, Cover and Splash Guard. Disconnect the ribbon cable from the Cover

3.

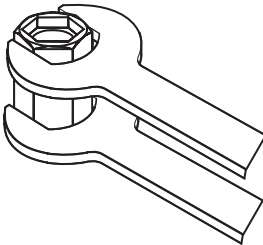

Hold a wrench across the flats of the metal connector. Unscrew the filter using another wrench as shown. Clean or replace the Filter as necessary. Refit the Filter making sure it is screwed fully home. **Do not overtighten.**

4.

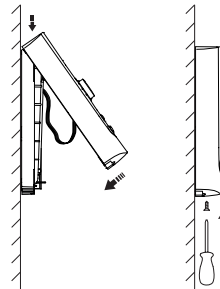

Make sure all plumbing connections are sealed before restoring the water supply. **Re-prime the appliance** (refer to "**Installation**") before restoring the electricity supply. Refit the Splash Guard, ribbon cable and Cover.

WIRING DIAGRAM

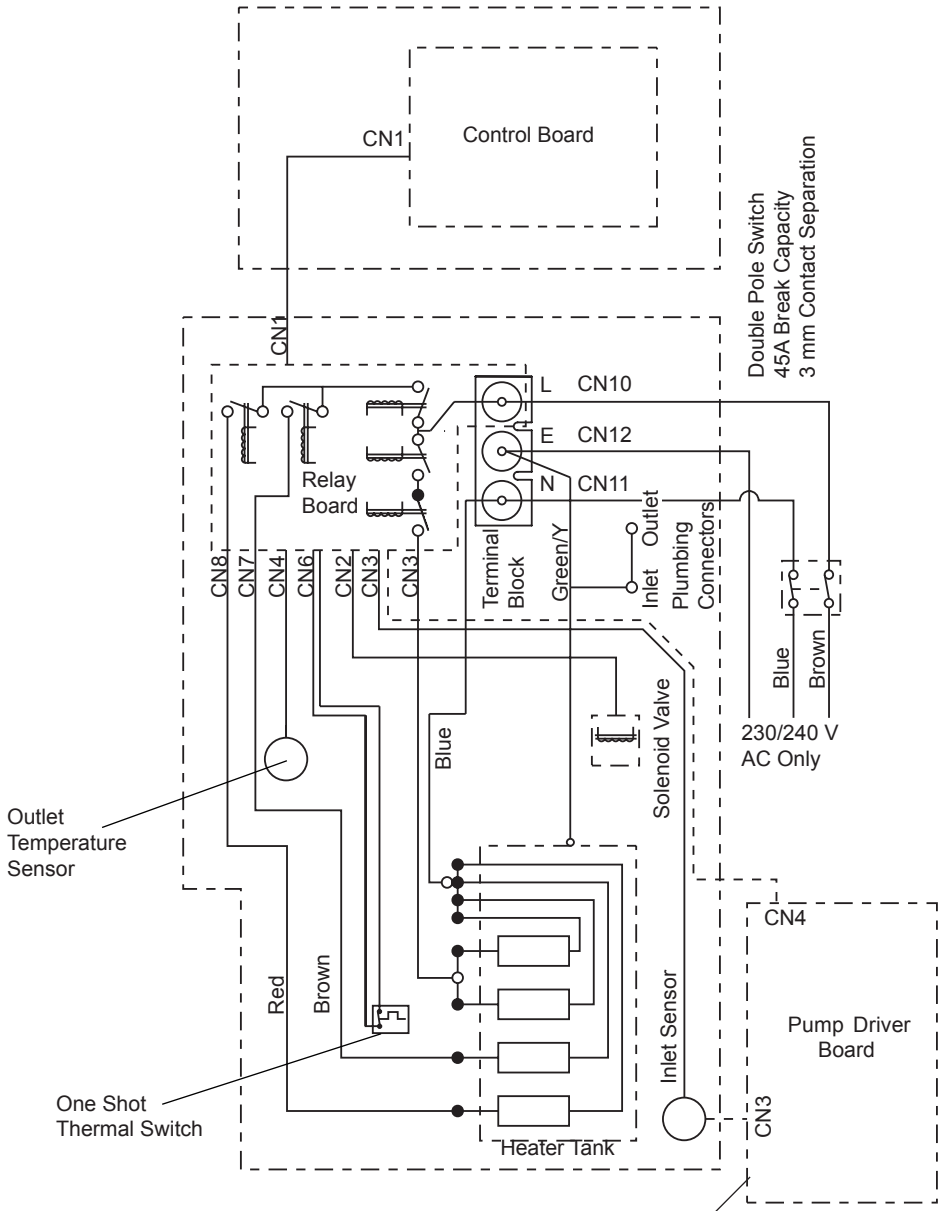

(Fitted to Standard Extra and Flex Extra models only.)

SPARE PARTS

405.58	Inlet Connector Assembly
406.27	Inlet Filter.
1643.100	Thermal Trip.
1643.101	Tank Assembly 9 kW/230 V 9.8 kW/240 V (earth wire not included).
1643.102	Tank Assembly 8.2 kW/230 V 9 kW/240 V (earth wire not included).
1643.103	Terminal Block/Earth Wire/Neutral Wire.
1643.104	Relay Board (including screws).
1643.105	Top and Bottom Cover Inserts (white).
1643.106	Control PCB - Standard and Flex models only (including screws).
1643.107	Control PCB - Memory model only (including screws).
1643.108	Cover - Standard model only (Control PCB not included).
1643.109	Cover - Memory model only (Control PCB not included).
1643.110	Cover - Flex model only (Control PCB not included).
1643.111	Fuse.
1643.112	Drain Pump PCB - Extra models only.
1643.113	Component Pack (components identified "B").
1643.114	Splash Guard.
1643.144	Top and Bottom Cover Inserts (grey).
1643.148	Seal Pack (components identified "A").
1643.149	Flow Valve Assembly (components identified "C").

SPARE PARTS

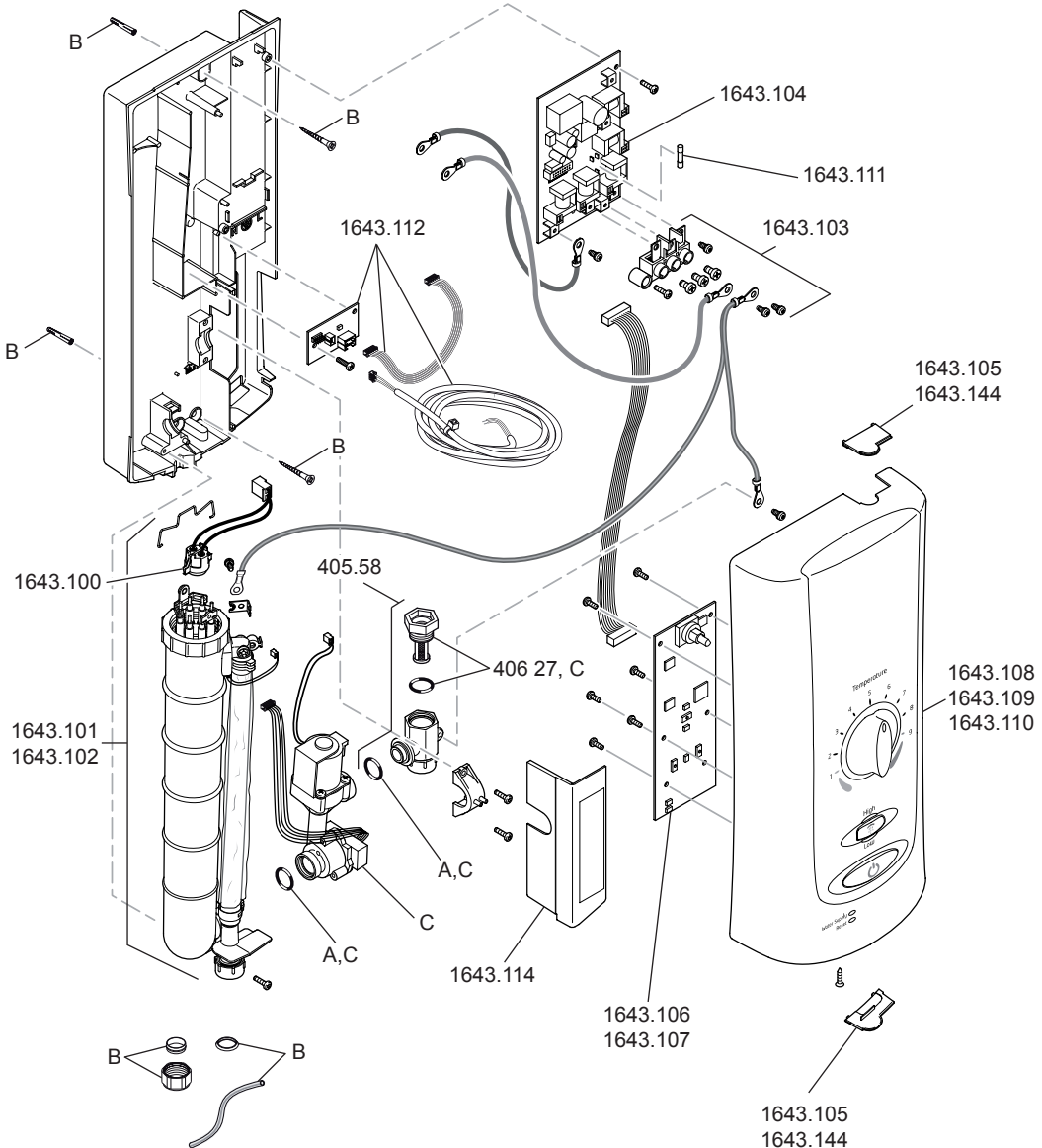

NOTES

NOTES

CUSTOMER SERVICE

Guarantee of Quality

Mira Showers guarantee your product against any defect in materials or workmanship for the period shown in the Guarantee Registration Document included with your shower.

Alternatively, to confirm the applicable guarantee period please contact Customer Services.

To validate the guarantee, please return your completed registration card.

Within the guarantee period we will resolve defects, free of charge, by repairing or replacing parts or modules as we may choose.

To be free of charge, service work must only be undertaken by Mira Showers or our approved agents.

Service under this guarantee does not affect the expiry date.

The guarantee on any exchanged parts or product ends when the normal product guarantee period expires.

Not covered by this guarantee:

Damage or defects arising from incorrect installation, improper use or lack of maintenance, including build-up of limescale.

Damage or defects if the product is taken apart, repaired or modified by any persons not authorised by Mira Showers or our approved agents.

This guarantee is in addition to your statutory and other legal rights.

What to do if something goes wrong

If when you first use your shower, it doesn't function correctly, first contact your installer to check that installation and commissioning are satisfactory and in accordance with the instructions in this manual. We are on hand to offer you or your installer any advice you may need.

Should this not resolve the difficulty, simply contact our Customer Services Team who will give every assistance and, if necessary, arrange for our service engineer to visit. If the performance of your shower declines, consult this manual to see whether simple home maintenance is required. Please call our Customer Services Team to talk the difficulty through, request a service under guarantee if applicable, or take advantage of our comprehensive After-Sales Service.

As part of our quality and training programme calls may be recorded or monitored.

Our Customer Services Team is comprehensively trained to provide every assistance you may need: help and advice, spare parts or a service visit.

Spare Parts

We maintain an extensive stock of spares and aim to provide support throughout the product's expected life.

Spares can be purchased from approved stockists or merchants (locations on request) or direct from Customer Services.

Spares direct will normally be despatched within two working days. Payment can be made by Visa or MasterCard at the time of ordering. Should payment by cheque be preferred, a pro-forma invoice will be sent.

All spares are guaranteed for 12 months from date of purchase. Spares that have been supplied directly from us can be returned within one month from date of purchase, providing that they are in good order and the packaging is unopened.

Note! Returned spares will be subject to a 15% restocking charge and authorisation must be obtained before return. Please contact our Customer Services Team.

Note! In the interests of safety, spares requiring exposure to mains voltages can only be sent to competent persons.

Service

Our Service Force is available to provide a quality service at a reasonable cost. You will have the assurance of a Mira trained engineer/agent, genuine Mira spare parts and a 12 month guarantee on the repair.

Payment should be made directly to the engineer/agent using Visa, MasterCard or a cheque supported by a banker's card.

To Contact Us

England, Scotland, Wales and Northern Ireland

Mira Showers Customer Services

Telephone: 0870 241 0888, Mon to Fri 8:00 am - 5:30 pm
Sat 8:30 am - 3:30 pm

E-mail: technical@mirashowers.com

Fax: 01242 282595

By Post: Cromwell Road, Cheltenham,
Gloucestershire, GL52 5EP

Eire

Modern Plant Ltd (Dublin)

Telephone: 01 459 1344, Mon to Fri 9:00 am - 5:00 pm

E-mail: sales@modernplant.ie

Fax: Dublin 01 459 2329

Post: Otter House, Naas Road,
Clondalkin, Dublin 22

Modern Plant (Cork)

Telephone: 021 496 8755, Mon to Fri 9:00 am - 5:00 pm

E-mail: cork@modernplant.ie

Fax: 021 496 8607

Post: Tramore Road, Cork

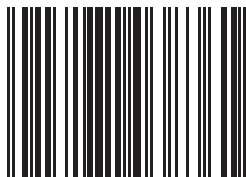

5 013181 038361 >

Mira is a registered trade mark of
Kohler Mira Limited.

The company reserves the right to alter
product specifications without notice.

www.mirashowers.com

mira
SHOWERS



FM 14648